

The complete product range

Onderhoud Giesser messen



HYGIENEPARTNER.nl
BRILLIANT

 **GIESSER**
MADE IN GERMANY

Service

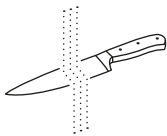

CLEANING

Look after your knives to protect their outstanding GIESSER quality for many years.



SHARPENING

Absolute precision: our sharpening recommendations.

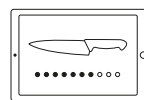

KNIFE MANAGEMENT

Improve your product safety, work processes and cost controlling.

How to make your Giesser knives last as long as possible:
tips on looking after your knives.

Cleaning and storage

Our knives with a plastic handle are dishwasher-proof. We nonetheless recommend that you clean them by hand to prevent staining and the build-up of extraneous rust, and to protect the cutting edge of the blade. After cleaning, keep your knives safe with protectors and by storing them in our knife blocks or Gastronorm tray insets. We also offer a wide range of knife bags, cases and boxes to help you transport your Giesser knives safely.



OUR GUARANTEE

All GIESSER knives with plastic handles are made entirely from materials that comply with the German Food and Commodities Act (LMBG).





KNIFE CARE

1 STORAGE

Store your knives in a dry, secure place. Never leave them lying around near children.

2 SAFETY

Giesser knives are very sharp. Be careful when cleaning, drying and handling their blades.

3 SHARPENING

Regularly sharpen the blade with the honing steel or a fine whetstone. This maximises the useful life of the cutting edge and keeps it sharp.

4 CUTTING BOARDS

Use a cutting board made from wood or plastic. Marble and granite boards damage the blade.

5 HANDLES

Our plastic handles are very low-maintenance. Wooden handles benefit from occasional treatments with suitable oils.

Have a look at our website for more information:
www.giesser.de

Looking after Giesser blades: regularly sharpen and hone the blade to keep it sharp – day after day and for many years to come.

Sharpening

Professional cooking and butcher knives have to withstand a wide variety of mechanical stress. All working environments are different, and no two cuts are alike. High mechanical pressure and varying foodstuffs have a corresponding impact on the blade. You can prevent wear by sharpening your Giesser knives regularly to protect their sharpness and their cutting-edge retention. All you need is a little practice and the right sharpening tools.

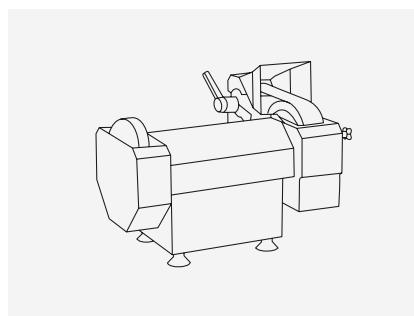

BECOME A SHARPENING EXPERT

Our sharpening seminars teach you how to sharpen and hone your hand knives using a honing steel, whetstone or a sharpening machine. Find out about the seminars on our website: www.giesser.de

Sharpening machines are additional methods to honing steels and whetstones. Like the manual tools, they protect the sharpness and the cutting edge of your knives. Find out more about our machines on page 152 or in the service section of our homepage.

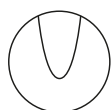

INCORRECT

An obtuse cutting angle leads to quick blunting of the cutting edge.



INCORRECT

Blades ground too thin (hollow grind) may chip even at minimal strain.



INCORRECT

Grinding the blade into a straight wedge shape reduces cutting-edge retention considerably.



CORRECT

The perfect blade: its slightly convex edge ensures both, sharpness and stability.

Honing steel

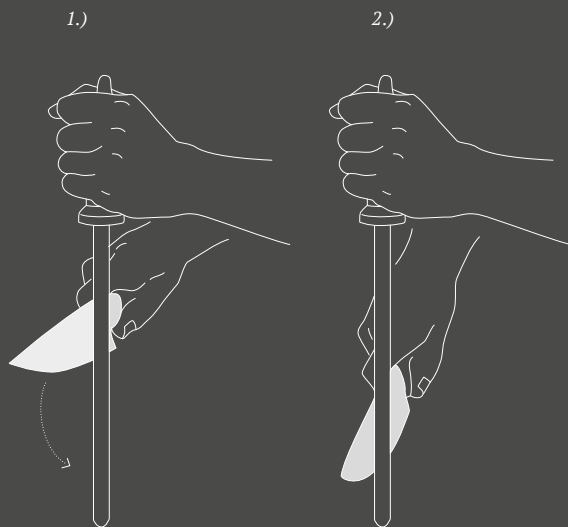

Just a few even strokes on a traditional honing steel will usually restore the sharpness of any blade. But different blades require different stroke techniques. Always slide the knife over the steel in a cutting motion at an angle of 15–20 degrees. Alternate between the left and right side, keep your wrist relaxed and move in a wide arc. The force with which the knife should be pressed against the steel depends on how worn the blade is. Do not use any pressure for a new, unsharpened blade, little pressure for a slightly worn blade and a lot of pressure for a heavily worn blade.

Whetstone

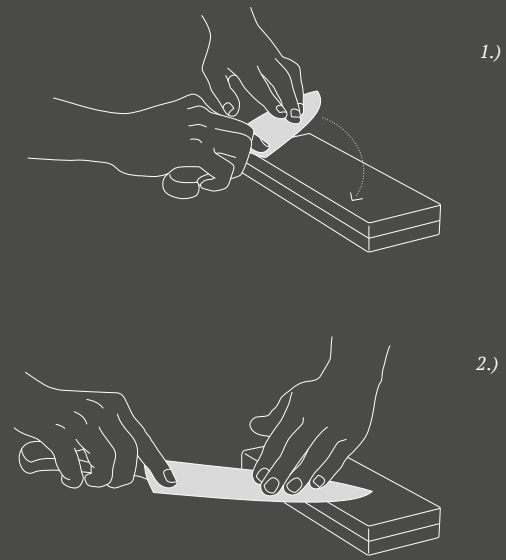

A whetstone allows you to sharpen even the bluntest knives from scratch. It achieves results where a honing steel fails. We recommend using combination whetstones with a fine grit side and an extra-fine grit side. Use an angle of 15–20 degrees, as you would with a honing steel. First, whet both sides of the blade on the rougher side of the stone by guiding them across the stone alternatingly and evenly. Afterwards, use the finer side to smooth the blade.

Organisation is key! MEMSYS improves your product security, boosts your work processes and helps you control spending.

Knife management

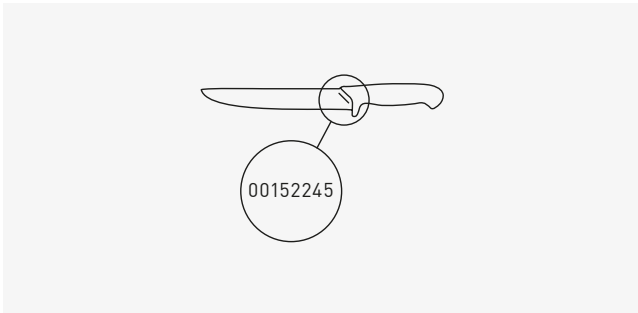

1 INDIVIDUAL LABELLING

Your Giesser knives can be labelled with sequential serial numbers upon request. This system gives you complete, transparent insight into their useful life from production to utilisation and disposal. We also offer customised labelling for companies.

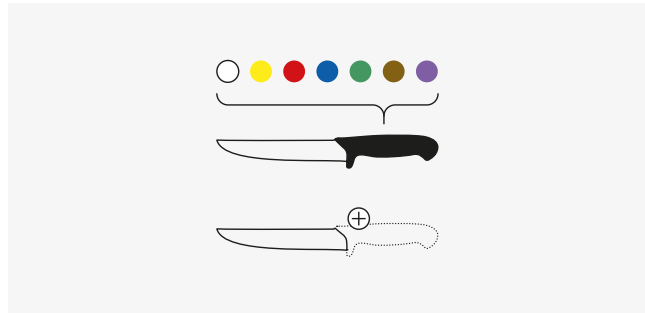

2 MEANINGFUL HANDLE COLOURS

Colour-coding your knives is an excellent way to assign them to different processes, departments or shifts. Giesser offers twelve handle colours as a standard. We are happy to provide you with individual or company-specific colours upon request.

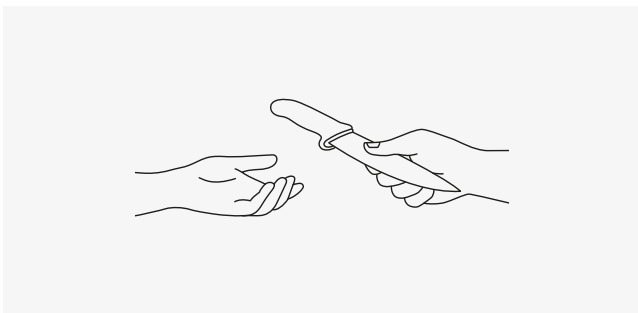

3 CONTROL

Each new knife's serial number is entered into the management system and assigned to the employee the knife is issued to. This makes it easy to monitor sharpening and maintenance intervals. New knives are only issued when a used one is returned; the condition of each used knife is verified upon its return.

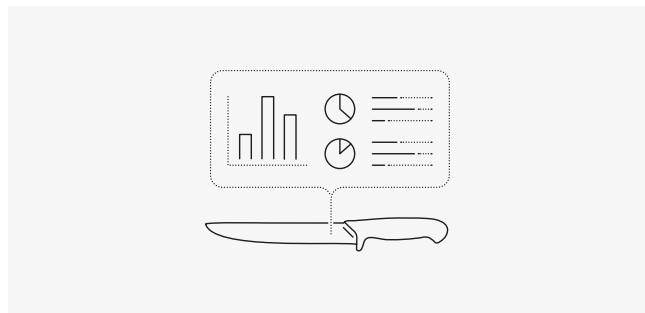

4 DOCUMENTATION

To ensure process security, MEMSYS supports seamless, permanent documentation that can be managed easily in Excel. This allows the user to analyse individual wear, current requirements and the exact cost involved. Veterinarians and auditors require such documentation within the scope of IFS certification.



Tool-Check

The one-stop program to manage, personalise and control tools and equipment.



Find out more: www.giesser.de/english/News/Downloads/Brochures

Knife management has become an indispensable part of the food processing industry and its various certifications. Giesser's 'Tool Check' software manages your tools and staff and even offers data analysis. This allows you to identify the user of every single knife. Your employees feel greater responsibility for their knives and handle them more carefully, helping you save expenses. No specialist IT knowledge is required to operate this self-explanatory program. Thanks to its web-based interface, Tool Check stays updated on its own without any complicated steps on your part.

JOHANNES GIESSER MESSERFABRIK GMBH

Johannes-Giesser-Straße 1
DE-71364 Winnenden · Germany

Telefon +49(0)71 95/18 08-0
Telefax +49(0)71 95/6 44 66
E-Mail info@giesser.de

You can find all products from the
Johannes Giesser Messerfabrik at
www.giesser.de

Technical or visual changes, layout and printing errors
excepted. Colouration of the actual products may deviate
from printed images for technical reasons.



Brilliant Group B.V.

Typograaf 8
6921 VB Duiven

W: www.hygienepartner.nl
E: info@hygienepartner.nl
T: 026 - 3190 590

